

USER'S GUIDE



Calibration of Digital Transmitters with Vaisala HUMICAP[®] Humidity Indicator HMI41 Cables 19164ZZ and 25917ZZ

PUBLISHED BY

Vaisala Oyj
P.O. Box 26
FIN-00421 Helsinki
Finland

Phone (int.): +358 9 8949 1
Fax: +358 9 8949 2227

Visit our Internet pages at <http://www.vaisala.com/>

© Vaisala 2007

No part of this manual may be reproduced in any form or by any means, electronic or mechanical (including photocopying), nor may its contents be communicated to a third party without prior written permission of the copyright holder.

The contents are subject to change without prior notice.

Please observe that this manual does not create any legally binding obligations for Vaisala towards the customer or end user. All legally binding commitments and agreements are included exclusively in the applicable supply contract or Conditions of Sale.

Table of Contents

CHAPTER 1	
GENERAL INFORMATION	3
Safety	3
Recycling	4
Trademarks	4
Warranty	5
CHAPTER 2	
PRODUCT OVERVIEW	7
Introduction	7
HMI41 with Calibration Option	7
Selecting HMI41 Calibrator Function	8
CHAPTER 3	
CALIBRATION	11
Getting Started	11
One-Point Offset and Gain Calibrations.....	15
HMI41 as a Reference Meter	15
HMI41 as a Terminal.....	17
Two-Point Calibration	18
HMI41 as a Reference Meter	19
HMI41 as a Terminal.....	21
CHAPTER 4	
TROUBLESHOOTING	25
APPENDIX A	
QUICK REFERENCE TO CALIBRATION	27
Selecting the Calibrator Function	27
Offset and Gain Calibrations with HMI41 as a Reference Meter	28
Offset and Gain Calibrations with HMI41 as a Terminal	29
Two-Point Calibration with HMI41 as a Reference Meter ...	30
Two-Point Calibration with HMI41 as a Terminal	31

This page intentionally left blank.

CHAPTER 1

GENERAL INFORMATION

This chapter provides general notes for the manual and the product.

Safety

Throughout the manual, important safety considerations are highlighted as follows:

WARNING	Warning alerts you to a serious hazard. If you do not read and follow instructions very carefully at this point, there is a risk of injury or even death.
----------------	---

CAUTION	Caution warns you of a potential hazard. If you do not read and follow instructions carefully at this point, the product could be damaged or important data could be lost.
----------------	--

NOTE	Note highlights important information on using the product.
-------------	---

Recycling



Recycle all applicable material.



Dispose of batteries and the unit according to statutory regulations.
Do not dispose of with regular household refuse.

Trademarks

HUMICAP[®] is a registered trademark of Vaisala.

Warranty

Vaisala hereby represents and warrants all Products manufactured by Vaisala and sold hereunder to be free from defects in workmanship or material during a period of twelve (12) months from the date of delivery save for products for which a special warranty is given. If any Product proves however to be defective in workmanship or material within the period herein provided Vaisala undertakes to the exclusion of any other remedy to repair or at its own option replace the defective Product or part thereof free of charge and otherwise on the same conditions as for the original Product or part without extension to original warranty time. Defective parts replaced in accordance with this clause shall be placed at the disposal of Vaisala.

Vaisala also warrants the quality of all repair and service works performed by its employees to products sold by it. In case the repair or service works should appear inadequate or faulty and should this cause malfunction or nonfunction of the product to which the service was performed Vaisala shall at its free option either repair or have repaired or replace the product in question. The working hours used by employees of Vaisala for such repair or replacement shall be free of charge to the client. This service warranty shall be valid for a period of six (6) months from the date the service measures were completed.

This warranty is however subject to following conditions:

- a) A substantiated written claim as to any alleged defects shall have been received by Vaisala within thirty (30) days after the defect or fault became known or occurred, and
- b) The allegedly defective Product or part shall, should Vaisala so require, be sent to the works of Vaisala or to such other place as Vaisala may indicate in writing, freight and insurance prepaid and properly packed and labelled, unless Vaisala agrees to inspect and repair the Product or replace it on site.

This warranty does not however apply when the defect has been caused through

- a) normal wear and tear or accident;
- b) misuse or other unsuitable or unauthorized use of the Product or negligence or error in storing, maintaining or in handling the Product or any equipment thereof;
- c) wrong installation or assembly or failure to service the Product or otherwise follow Vaisala's service instructions including any repairs or installation or assembly or service made by unauthorized personnel not approved by Vaisala or replacements with parts not manufactured or supplied by Vaisala;
- d) modifications or changes of the Product as well as any adding to it without Vaisala's prior authorization;
- e) other factors depending on the Customer or a third party.

Notwithstanding the aforesaid Vaisala's liability under this clause shall not apply to any defects arising out of materials, designs or instructions provided by the Customer.

This warranty is expressly in lieu of and excludes all other conditions, warranties and liabilities, express or implied, whether under law, statute or otherwise, including without limitation any implied warranties of merchantability or fitness for a particular purpose and all other obligations and liabilities of Vaisala or its representatives with respect to any defect or deficiency applicable to or resulting directly or indirectly from the Products supplied hereunder, which obligations and liabilities are hereby expressly cancelled and waived. Vaisala's liability shall under no circumstances exceed the invoice price of any Product for which a warranty claim is made, nor shall Vaisala in any circumstances be liable for lost profits or other consequential loss whether direct or indirect or for special damages.

This page intentionally left blank.

CHAPTER 2

PRODUCT OVERVIEW

This chapter introduces the features, advantages, and the product nomenclature.

Introduction

HMI41 with Calibration Option

Vaisala HUMICAP[®] Humidity Indicator HMI41 can be used as a field calibrator for various Vaisala humidity transmitters. There are four different calibration cables available:

- 19116ZZ for the calibration of HMD/W60/70 and HMP140 series analogue transmitters
- **19164ZZ for the calibration of HMP230 series digital transmitters**
- 19165ZZ for the calibration of the HMD/W20/30 and HMP130 series analogue transmitters
- **25917ZZ for the calibration of HMT100/HMT330 series digital transmitters**

Note that HMI41 has to meet the same requirements as the transmitter to be calibrated. There are three calibration modes available: offset (dry point), gain (wet point) and two-point calibration. All of these can be performed using HMI41 either as a reference meter (for example when the transmitter is mounted in an air-conditioning channel) or only as a terminal for visualizing and setting the transmitter's RH reading (for example when the transmitter does not have a local keypad and it is calibrated against salt solutions without a personal computer).

Calibration is quick and easy to perform. In calibration, HMI41 measures relative humidity with the reference probe and receives the RH information from the transmitter. HMI41 sends the measured or manually set reading to the transmitter which makes calculations and necessary corrections. The data is then stored in the transmitter memory.

Selecting HMI41 Calibrator Function

The desired calibrator function is selected in the HMI41 setup menu. To enter the setup mode, first press the **ON/OFF** button and the following appears:

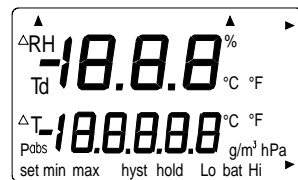

Then release the **ON/OFF** button and within 1 ... 2 seconds press both **ENTER** and **MODE** buttons until the following text appears on the display:



After a few seconds, the text changes automatically to show the following:

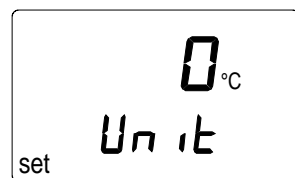

If the basic settings of HMI41 (display units, automatic power off function, display quantities and pressure) have to be changed, please refer to the HMI41 User's Guide. Otherwise, press **ENTER** repeatedly until the following text appears:

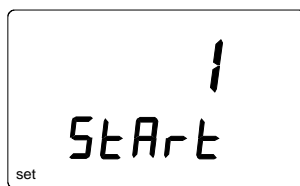

The number on the first line of the display corresponds to the following HMI41 functions:

- 1 = HMI41 as a humidity and temperature indicator
- 2 = HMI41 as a calibrator for HMD/W60/70 and HMP140 series analogue transmitters
- 3 = HMI41 as a calibrator for HMP230 and HMT100/HMT330 series digital transmitters
- 4 = HMI41 as a calibrator for the HMD/W20/30 and HMP130 series analogue transmitters

To calibrate HMP230, HMT100 or HMT330 series digital transmitters, select number 3 with buttons ▲ (number up) and ▼ (number down) and then press **ENTER**. The following text appears:

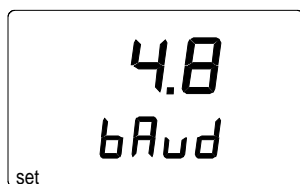

If the baud rate on the HMI41 display is not the same as that of the transmitter, change it with buttons ▲ and ▼. Use baud rate 19200 (= 19.2 on the HMI41 display) with the HMT100 and HMT330 series. When the baud rate is the same, press **ENTER** and the following appears:

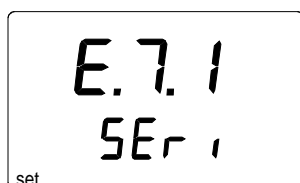

Letters and numbers correspond to the following:

- E = even parity
- 7 = data bits
- 1 = stop bits

These are also the factory settings of the HMP230 series. If the values on the HMI41 display do not correspond to those of the HMP230 series transmitter, change them with buttons ▲ and ▼ until they are correct, press **ENTER** and then **ON/OFF**. With the HMT100 and HMT330, use N, 8, 1:

N = none parity
8 = data bits
1 = stop bits

These selections are stored in the HMI41 memory; when HMI41 is turned on again, it will automatically wake up as a calibrator for digital transmitters with these line settings. If you wish to calibrate transmitters with different settings, or use HMI41 as an indicator or as a calibrator for some other transmitter type, these selections have to be made accordingly; refer to corresponding manuals for further details.

CHAPTER 3

CALIBRATION

There are four ways for calibrating the HMP230, HMT100 and HMT330 series transmitters with HMI41. You can perform a one-point offset or gain calibration using the HMI41 probe as a reference, or you can use HMI41 only as a terminal. Alternatively, you can perform a two-point calibration using the HMI41 probe as a reference, or you can use HMI41 only as a terminal. Offset and gain calibrations are performed in the same way and differ only for internal calculations. Two-point calibration is more accurate, and includes both offset and gain corrections. For performing a two-point calibration, you need two separate measurement points with a difference of at least 50 %RH between them.

NOTE

Two-point calibration is not supported for HMT100.

When the transmitter does not have a local keypad and it is calibrated against salt solutions without a personal computer, HMI41 can be used as a terminal for visualizing and setting the transmitter's RH reading.

For a successful calibration, it is essential that the probe of HMI41 and that of the transmitter are at the same temperature, and that the reference probe has been previously calibrated. Always allow enough time for the readings to stabilize. Note that the stabilization time depends on the ambient conditions and may vary from 10 minutes to a couple of hours.

Getting Started

After having selected the desired function (Selecting HMI41 Calibrator Function on page 8) and checked the line settings, turn

HMI41 off and connect the calibration cable to the EXT connector at the bottom of HMI41 (Figure 1 below). Connect the other end of the cable to the connector X5 in the HMP230 transmitter (Figure 2 on page 13). The connector X5 is also used for mounting the RS485/422 serial port module or current loop module; if a module is mounted, it must first be removed (for further details, see the HMP230 series User's Guide).

When calibrating series HMT100 transmitters, connect the cable to Service port RJ45 connector (RS232C) on the connector board, inside the housing.

When calibrating series HMT330 transmitters, connect the cable to Service Port RJ45 connector (RS232C) on the cover, inside the housing.

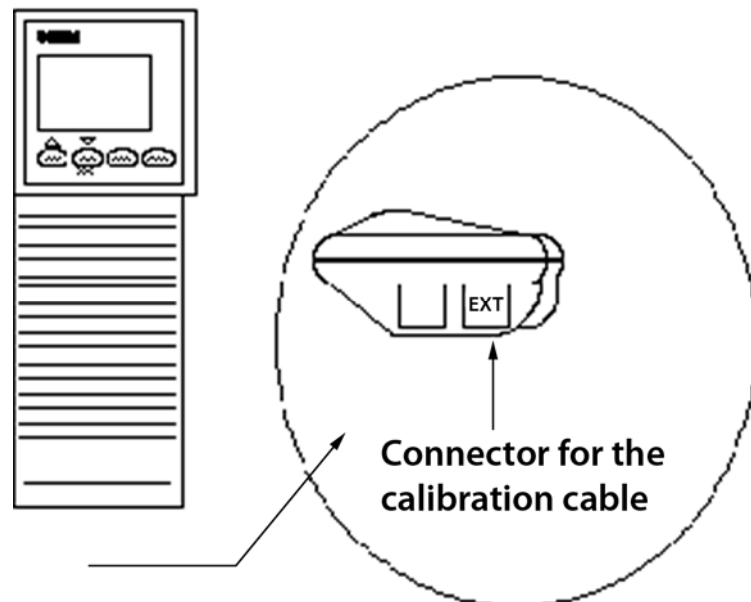

0605-009

Figure 1 Location of HMI41 Calibration Connector

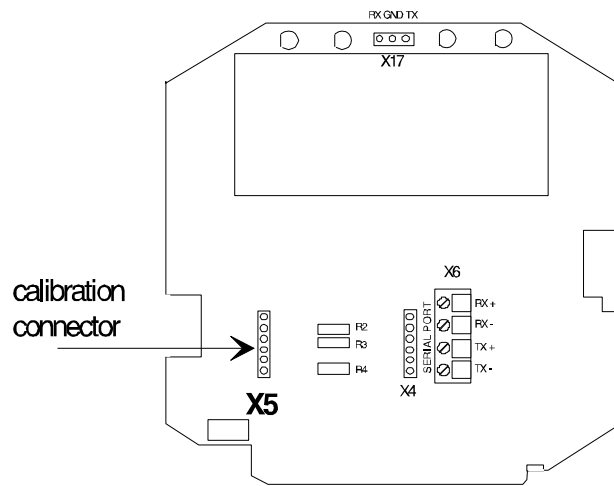

0605-010

Figure 2 Calibration Connector X5 in Series HMP230 Transmitters

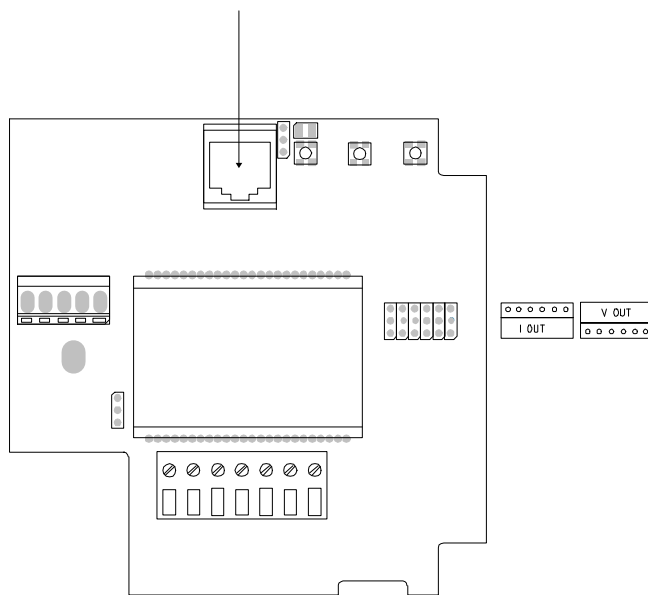

0605-011

Figure 3 Service Port in Series HMT100 Transmitters

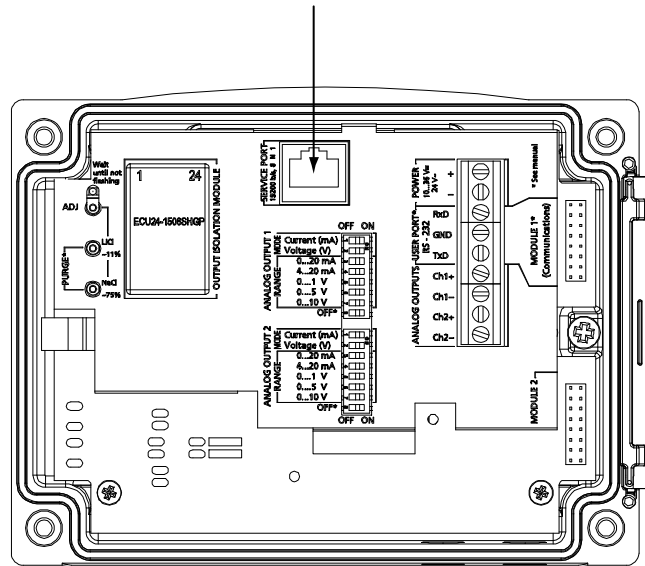

0605-012

Figure 4 Service Port in Series HMT330 Transmitters

After having connected the cable, turn HMI41 on with the **ON/OFF** button and wait until the following text appears on the display:



If you press the **HOLD** button, you will go on to two-point calibration mode, and if you press the **MODE** button, you will go on to gain calibration mode. You can return to offset calibration mode from two-point or gain calibration modes by pressing **MODE** or **HOLD** repeatedly. As offset and gain calibrations are performed in the same way, the following chapter is valid for both. For two-point calibration, see Two-Point Calibration on page 18.

One-Point Offset and Gain Calibrations

Select the desired calibration with buttons ▲ and ▼. Select offset calibration if the humidity is < 65%RH and gain calibration if the humidity is > 65%RH:

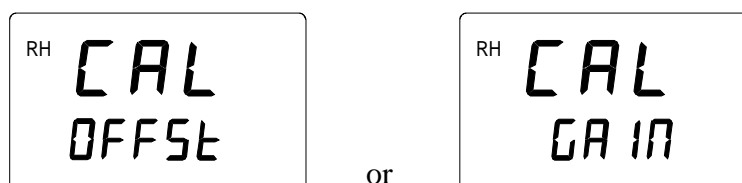

Press **ENTER** to acknowledge the selection. A text similar to the following appears on the display:

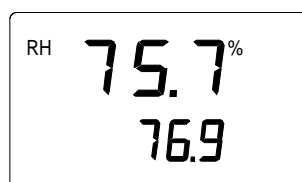

In following chapters, you will find instructions for performing offset and gain calibrations in two different ways.

HMI41 as a Reference Meter

The HMI41 reference probe is used to show the correct humidity value. Connect the cable and wait for the transmitter and reference probe readings to stabilize; when both readings are stable, press **ENTER** to conclude the calibration. When **ENTER** is pressed, the transmitter reading is corrected to the HMI41 reference probe reading.

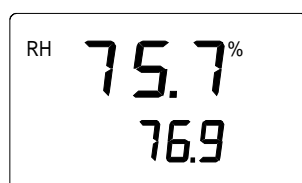

Numbers on the first line indicate the RH measured by the transmitter, and numbers on the second line indicate the RH measured by the reference probe. Let the readings stabilize.

If you prefer, you can change the display to show the difference in readings. Press **HOLD** and a text similar to the following appears:

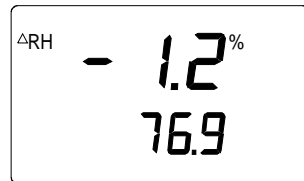

Numbers on the first line indicate how much the transmitter reading differs from that of the HMI41 reference probe. Numbers on the second line indicate the RH measured by the reference probe. You can return to the previous display by pressing **HOLD** again.

When the readings have stabilized, press **ENTER** in either of these two display modes to conclude the calibration. If the calibration has been successful, the following text appears:



The data is now stored in the transmitter memory. If the calibration has not been successful, the following appears:



In this case, perform the calibration again. Whether the calibration was successful or not, HMI41 always returns to show the selected calibration mode:



or



After having successfully completed the calibration, turn HMI41 off and disconnect the cable.

HMI41 as a Terminal

If the transmitter does not have a local keypad and it is calibrated against salt solutions, HMI41 can be used for visualizing and setting the transmitter's RH reading manually.

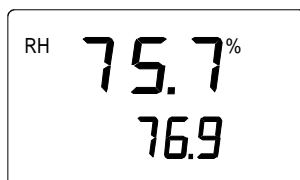

Numbers on the first line indicate the RH measured by the transmitter, and numbers on the second line indicate the RH measured by the HMI41 probe. Let the readings stabilize and press **MODE**. The following appears:

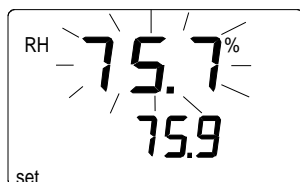

HMI41 now works only as a terminal for setting the humidity reading. Numbers on the first line are blinking, and numbers on the second line indicate the RH measured by the transmitter. You can now set the blinking reading to the correct value (for example to the equilibrium RH of the salt solution) with buttons **▲** and **▼**. Press **ENTER** to conclude the calibration. If the calibration has been successful, the following text appears:



The data is now stored in the transmitter memory. If the calibration has not been successful, the following appears:



In this case, perform the calibration again. Whether the calibration was successful or not, HMI41 always returns to show the selected calibration mode:

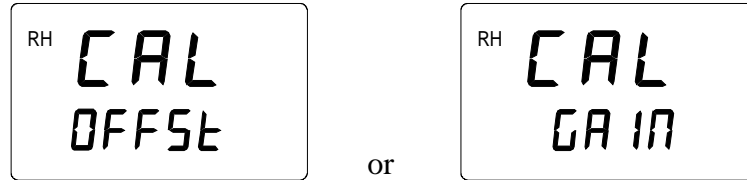

After having successfully completed the calibration, turn HMI41 off and disconnect the cable.

Two-Point Calibration

In two-point calibration mode, both offset and gain corrections are made. This calibration mode is more accurate than offset or gain calibrations. For performing a two-point calibration you need two reference points with a difference of at least 50 %RH between them.

NOTE

Two-point calibration is not supported for HMT100.

Select two-point calibration with buttons ▲ and ▼:

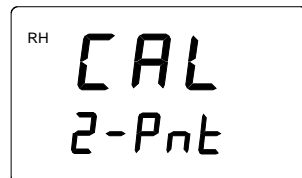

Press **ENTER** and the following text appears on the display for about 1 ... 2 seconds:

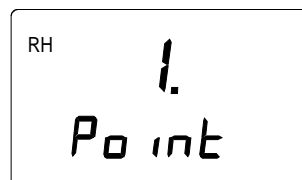

HMI41 as a Reference Meter

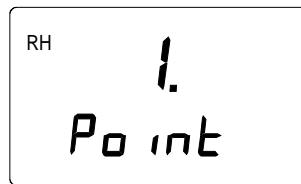

Normally, the HMI41 reference is needed for calibration. Insert the HMI41 probe and the transmitter probe to the lower humidity. Within 1 ... 2 seconds the display changes automatically to show a text similar to the following:

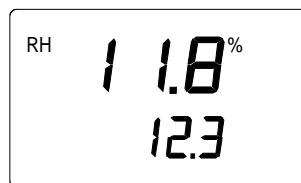

Numbers on the first line indicate the RH measured by the transmitter, and numbers on the second line indicate the RH measured by the reference probe. Let the readings stabilize. If you prefer, you can change the display to show the difference in the readings. Press **HOLD** and a text similar to the following appears:

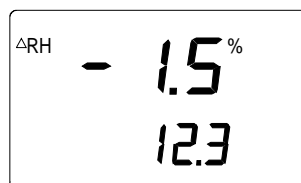

Numbers on the first line indicate how much the transmitter reading differs from that of HMI41. Numbers on the second line indicate the RH measured by the reference probe. You can return to the previous display by pressing **HOLD** again. Let the readings stabilize. Press **ENTER**, and the following appears:

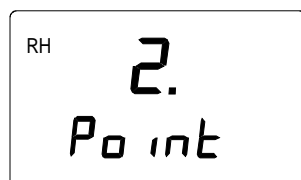

Insert both probes to the higher humidity. Within 1 ... 2 seconds, the display changes automatically to show a text similar to the following:

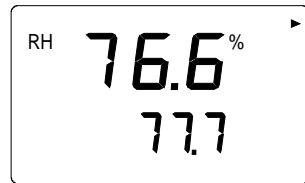

Numbers on the first line indicate the RH measured by the transmitter, and numbers on the second line indicate the RH measured by the reference probe. Let the readings stabilize. If you prefer, you can change the display to show the difference in the readings. Press **HOLD** and a text similar to the following appears:

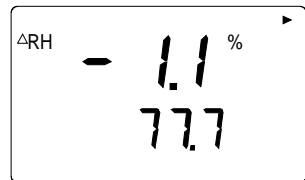

Numbers on the first line indicate how much the transmitter reading differs from that of the HMI41 reference probe. Numbers on the second line indicate the RH measured by the reference probe. You can return to the previous display by pressing **HOLD** again.

When the readings have stabilized, press **ENTER** in either of these two display modes to conclude the calibration. If the calibration has been successful, the following text appears:



The data is now stored in the transmitter memory. If the calibration has not been successful, the following appears:



In this case, perform the calibration again. Whether the calibration was successful or not, HMI41 always returns to show the selected calibration mode:

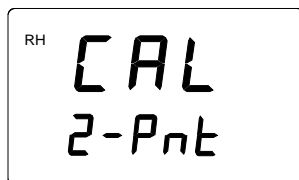

After having successfully completed the calibration, turn HMI41 off and disconnect the cable.

HMI41 as a Terminal

HMI41 can also be used only as a terminal for visualizing and setting the transmitter's RH reading (for example when the transmitter does not have a local keypad and it is calibrated against salt solutions without a personal computer).

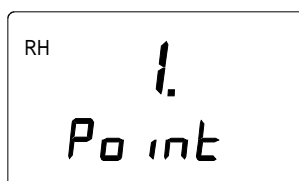

Insert the transmitter probe to the lower humidity. Within 1 ... 2 seconds the display will automatically change to show a text similar to the following:

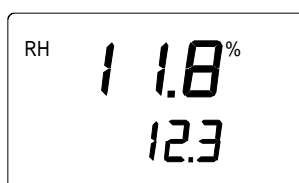

Numbers on the first line indicate the RH measured by the transmitter, and numbers on the second line indicate the RH measured by the HMI41 probe.

Let the readings stabilize. Press **MODE** and a text similar to the following appears:

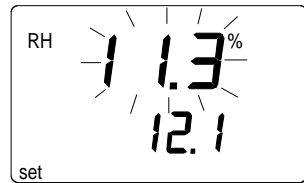

Numbers on the first line are blinking, and numbers on the second line indicate the RH measured by the transmitter. You can now set the blinking reading to the correct value (for example to the equilibrium RH of the salt solution) with buttons ▲ and ▼. Press **ENTER**, and the following appears:

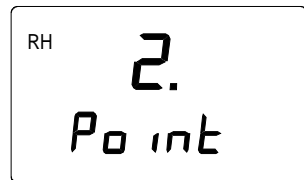

Insert the transmitter probe to the higher humidity. Within 1 ... 2 seconds, the display will automatically change to show a text similar to the following:

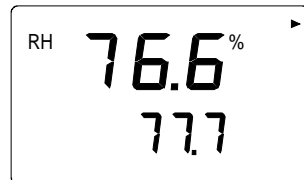

Numbers on the first line indicate the RH measured by the transmitter, and numbers on the second line indicate the RH measured by the HMI41 probe. Let the readings stabilize. Press **MODE**, and a text similar to the following appears:

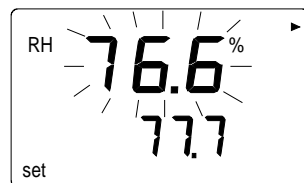

Numbers on the first line are blinking, and numbers on the second line indicate the RH measured by the transmitter. You can now set the blinking reading to the correct value (for example to the equilibrium RH of the salt solution) with buttons ▲ and ▼. Press **ENTER** to conclude the calibration. If the calibration has been successful, the following text appears:



RH CAL
PASS

The data is now stored in the transmitter memory. If the calibration has not been successful, the following appears:



RH CAL
Error

In this case, perform the calibration again. Whether the calibration was successful or not, HMI41 always returns to show the selected calibration mode:



RH CAL
2-Point

After having successfully completed the calibration, turn HMI41 off and disconnect the cable.



This page intentionally left blank.

CHAPTER 4

TROUBLESHOOTING

In the following table you will find a summary of the few error messages that may appear during calibration:

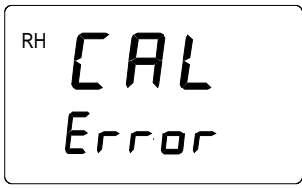
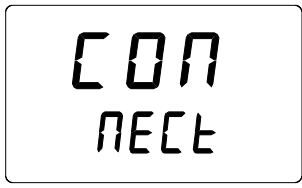
Table 1 Troubleshooting Table

Display:	What to Do:	What is the Reason?
 <p>RH CAL Error</p>	Perform the calibration again.	This message may appear for example if the difference between the reference humidities in two-point calibration is too small.
 <p>CON NECT</p>	Wait.	This message may appear during calibration when HMI41 is trying to contact the transmitter.
 <p>CON Error</p>	Check the connection of the calibration cable. Check that the line settings in the HMI41 memory correspond to those of the transmitter.	The calibration cable is not correctly connected. The line settings of HMI41 and the transmitter do not correspond.

This page intentionally left blank.

APPENDIX A

QUICK REFERENCE TO CALIBRATION

It is recommended that this quick reference guide is used only as a checking list for those who already know how to operate HMI41 as a calibrator. For those who take it into use for the first time, the User's Guide gives useful information that is not included in this quick reference guide.





Selecting the Calibrator Function

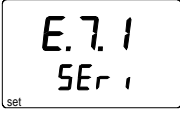

For selecting the calibrator function, press **ON/OFF** until you can see some text on the display. Then release the **ON/OFF** button and press within 1 ... 2 seconds both **ENTER** and **MODE** buttons until the text "setup" appears on the display. Then follow the instructions of the table below.

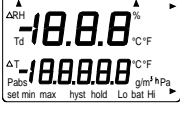
Display:	What to Do	Press
	Wait for a few seconds.	
	If the basic settings have been given, press ENTER . If they have not been given, refer to the HMI41 User's Guide.	Press ENTER repeatedly:
	Select the HMI41 function: 1 = indicator 2 = calibrator for HMD/W60/70 and HMP140 series analogue transmitters 3 = calibrator for HMP230 or HMT100/330 transmitters 4 = calibrator for HMD/W20/30 and HMP130 series transmitters	▲ (number up) or ▼ (number down) ENTER

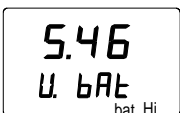

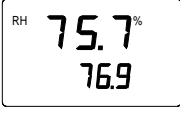
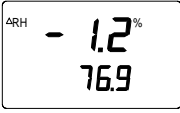



Display:	What to Do	Press
	Check that the baud rate corresponds to that of the HMP230 transmitter (4.8 - 4800 baud), or HMT100/330 transmitters (19.2 - 19200 baud).	▲ (number up) or ▼ (number down) ENTER
	Check that these line settings correspond to those of the HMP230 transmitter (E, 7, 1), or the HMT100/330 transmitters (N, 8, 1).	▲ (number up) or ▼ (number down) ENTER ON/OFF

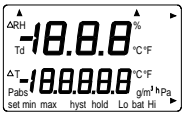

Offset and Gain Calibrations with HMI41 as a Reference Meter

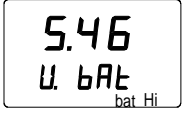
Display:	What to Do	Press
	HMI41 has been turned on.	
	Indication of the software version (if the version is 1.02 or more)	
	Indication of the battery voltage.	
	Select the desired calibration mode: offset : humidity < 65%RH gain : humidity > 65%RH	▲ (number up) or ▼ (number down) ENTER
	Let the readings stabilize. Conclude the calibration. Alternatively, you can change the display to show the difference in the readings.	ENTER to conclude or HOLD to have the difference on the display
	Let the readings stabilize. Conclude the calibration or return to the previous display mode.	ENTER to conclude or HOLD to return to the previous display mode

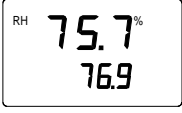



Display:	What to Do	Press
	Calibration has been successful.	ON/OFF (disconnect the cable)
	Calibration has not been successful. Perform the calibration again.	



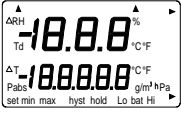

Offset and Gain Calibrations with HMI41 as a Terminal

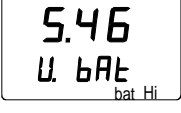
Display:	What to Do	Press
	HMI41 has been turned on.	
	Indication of the software version (if the version is 1.02 or more).	
	Indication of the battery voltage.	
	Select the desired calibration mode: offset : humidity < 65%RH gain : humidity > 65%RH	▲ (number up) or ▼ (number down) ENTER
	Let the readings stabilize.	MODE
	Set the blinking RH reading to the correct value (e.g. to the equilibrium RH of the salt solution).	▲ (number up) or ▼ (number down) ENTER to conclude

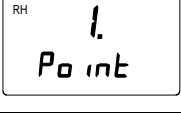
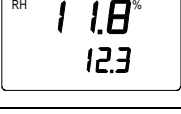
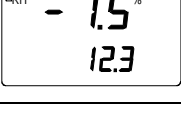

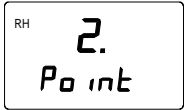
Display:	What to Do	Press
	Calibration has been successful.	ON/OFF (disconnect the cable)
	Calibration has not been successful. Perform the calibration again.	

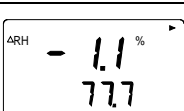

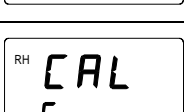

Two-Point Calibration with HMI41 as a Reference Meter

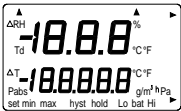
Display:	What to Do	Press
	HMI41 has been turned on.	
	Indication of the software version (if the version is 1.02 or more).	
	Indication of the battery voltage.	
	Select the desired calibration mode.	▲ (number up) or ▼ (number down) ENTER
	Insert the HMI41 probe and the transmitter probe to the lower humidity.	
	Let the readings stabilize. Alternatively, you can change the display to show the difference in readings.	ENTER to go on or HOLD to have the difference on the display
	Let the readings stabilize. If you prefer, you can return to the previous display.	ENTER to go on or HOLD to return to the previous display

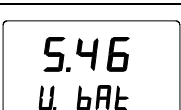
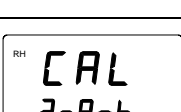
	Insert the HMI41 probe and the transmitter probe to the higher humidity.	
	Let the readings stabilize. Conclude the calibration. Alternatively, you can change the display to show the difference in readings.	ENTER to conclude or HOLD to have the difference on the display
	Let the readings stabilize. Conclude the calibration or return to the previous display.	ENTER to conclude or HOLD to return to the previous display
	Calibration has been successful.	ON/OFF (disconnect the cable)
	Calibration has not been successful. Perform the calibration again.	

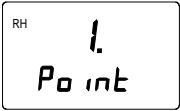
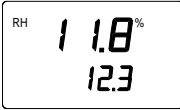
Two-Point Calibration with HMI41 as a Terminal

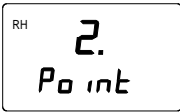
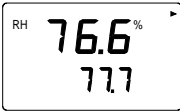
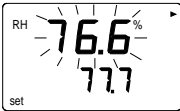
DISPLAY	DESCRIPTION	PRESS
	HMI41 has been turned on.	
	Indication of the software version (if the version is 1.02 or more).	
	Indication of the battery voltage.	
	Select the desired calibration mode.	▲ (number up) or ▼ (number down) ENTER

	<p>Insert the transmitter probe to the lower humidity.</p>	
	<p>Let the readings stabilize.</p>	<p>MODE</p>
	<p>Set the blinking RH reading to the correct value (e.g. to the equilibrium RH of the salt solution).</p>	<p>▲ (number up) or ▼ (number down) ENTER</p>
	<p>Insert the transmitter probe to the higher humidity.</p>	
	<p>Let the readings stabilize.</p>	<p>MODE</p>
	<p>Set the blinking RH reading to the correct value (e.g. to the equilibrium RH of the salt solution).</p>	<p>▲ (number up) or ▼ (number down) ENTER to conclude</p>
	<p>Calibration has been successful.</p>	<p>ON/OFF (disconnect the cable)</p>
	<p>Calibration has not been successful. Perform the calibration again.</p>	



www.vaisala.com